

PLAFO 430 TRACK



Round, track mounted luminaire with selection of diffusers. Top quality SMD LED module with colour consistency MacAdams ≤ 3 , extensive portfolio of lumen ranges, CCTs and spectra. Variety of track adaptor integrated drivers: standard EVG on/off, DALI and wireless controlled as MasterConnect or Casambi on request. Remote, wireless occupancy & daylight sensor available to allow significant energy savings and wireless connectivity. Mounting on universal track systems Global / Unipro. Track adaptor for any other type of track system on request. Body is made of aluminium and steel. Standard colour RAL 9005S, any other colour from basic RAL range available at no extra cost. Variety of diameters, diffusers, lumen outputs and drivers allows to use this luminaire in different types of lighting projects. Luminous flux & Luminaire Power tolerance up to 10%. System power consumption depends on components used. Luminous efficacy depends on type of LED's, electronics, optics and diffuser. The most up to date technical parameters can be found on our website and in database of LDT files.

Lighting direction



PDF datasheet:



PLAFO 430 TRACK

Mounting:	Track mounted
Body material:	Steel and aluminium
Colour:	Standard black RAL 9005S, other RAL colours on request
Lumen output:	Standard up to 5000 lm, any other on request
LED module:	Signify (Philips), Tridonic or equivalent COB LED modules
Colour temperature:	3000/4000K, other on request
Colour Rendering:	CRI>80 in standard, other on request
Driver:	EVG on-off/DALI/MC (MasterConnect)/Casambi, other on request
Wireless control:	Philips MasterConnect / Casambi, other on request
Daylight/Occupancy sensor:	Wireless MCS sensor
Emergency unit:	N/A
Operating temperature range:	0°C ... +35°C
IP Class:	IP20 in standard
Power:	220-240V 50/60Hz
Lighting direction:	Direct
Light distribution:	Symmetric
Diffuser:	OP white acrylic, MP19H microprismatic UGR<19
Beam angle:	All types available in our LDT file database
Warranty:	5 Years standard warranty

PLAFO 430 TRACK track mounted luminaire

All current index numbers, lumen outputs, power consumption and many other technical information are available in our 2024 pricelist. Details on wireless lighting control systems on page number 896.



LP long mounting pipe 500 mm



Energy saving MasterConnect wireless lighting control system with daylight and movement detection technology on request.

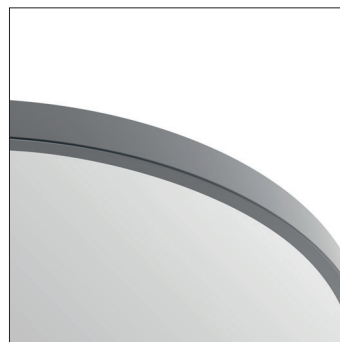

OP opal diffuser



MP19H microprismatic diffuser



MCS wireless daylight&occ sensor



XCS wireless switch

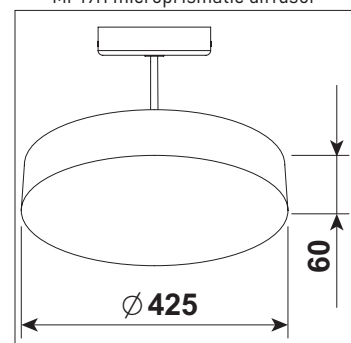

Basic dimensions